



WLL

The working load limit marked on the shackle and written in the next pages refer to in-line loading, where the load is perpendicular to pin of the shackle. Side load should be avoided. When the shackle is side loaded, not aligned to the force axis), the following reduction factors must be taken into account.

PORTATA

La portata indicata sul grillo e nelle pagine seguenti è riferita a sollevamenti con un unico tiro di fune dove il perno del grillo è perpendicolare all'asse di tiro. Gli sforzi laterali andrebbero evitati. In caso contrario quando il grillo viene sottoposto a sforzi laterali, non allineati all'asse di tiro, prevedere una riduzione di portata come indicato di seguito.

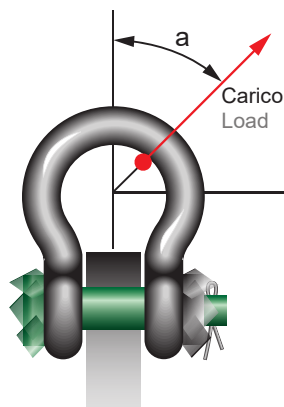
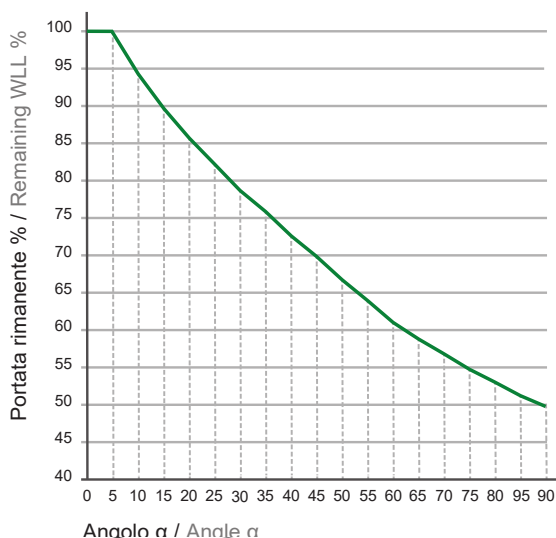

Percentuale di portata (carico massimo di utilizzo) rimanente in base all'angolo di carico.
Remaining WLL percentage at side load angle α

Grafico valido per tutti i grilli ad eccezione dei grilli sling P6033.
This graphic is valid for all the shackles except P6033 sling shackles.

General criteria of use

- Do not side load the shackles.
- Always check the efficiency of the shackle before lifting.
- Make sure the pin is well screwed against the bracket using the whole thread.
- Never use a bolt or something different from original pin.
- Never use a shackle in contact with acids.
- Never use a shackle against sharp edges.

Criteri di utilizzo

- Non sottoporre il grillo a tiri disassati che possano farlo ruotare danneggiandolo.
- Controllare sempre l'efficienza del grillo prima di ogni sollevamento
- Assicurarsi che il perno sia ben avvitato contro la staffa utilizzando tutta la filettatura.
- Mai utilizzare un bullone o qualcosa di diverso dal perno originale.
- Mai utilizzare un grillo a contatto con acidi.
- Mai utilizzare un grillo contro spigoli vivi.

**DECLASSAMENTO DELLA PORTATA
IN PRESENZA DI TEMPERATURE ELEVATE**
LOAD REDUCTION DUE TO ELEVATED TEMPERATURES

Temperatura Temperature	Portata WLL
fino a 200°C	100%
200°C ÷ 300°C	90%
300°C ÷ 400°C	75%
> 400°C	non consentito / not allowed

TOLLERANZE
TOLERANCES

Ø Perno Ø Pin	
	≤ 2 t: +/- 1 mm
	≥ 3,2 t: +/- 2 mm
Larghezza interna perno Pin inside width	≤ 2 t: +/- 2,5 mm
	≥ 3,25 t ≤ 9,5 t: +/- 3 mm
	≥ 12 t: +/- 4 mm
	> 25 t: +/- 5%

I grilli Green Pin® possono essere forniti con TAG RFID. Per informazioni www.fasitaly.com
Green Pin® shackles can be supplied with RFID TAG. For information www.fasitaly.com



Accessori per fune

Wire rope fittings

GRILLI
SHACKLES

BRACHE DI FUNE DI ACCIAIO
WIRE ROPE SLINGS AND AG

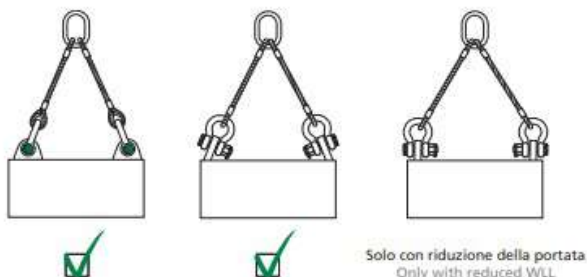

Verificare che il grillo sia collegato al carico correttamente, per esempio in asse con la fune.
Evitare carichi instabili o sovraccarichi.

Make sure that the shackle is supporting the load correctly i.e. along the axis of the shackle body centerline. Avoid bending loads, unstable loads and overloads.



Evitare imbragature dove il carico si muova sopra al perno del grillo; il perno potrebbe ruotare e svitarsi.

Avoid applications where the load moves over the shackle pin; the pin may rotate and possibly be unscrewed.

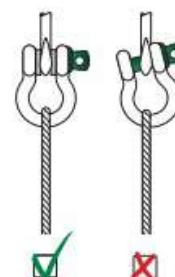

Posizionare una rondella ad entrambe le estremità del perno per evitare carichi eccentrici sul grillo.
Non cercare di ridurre la larghezza interna saldando rondelle o distanziali o restringendo le due estremità, perché verrebbe compromessa la portata del grillo.

To avoid eccentric loading of the shackle a loose spacer may be used on either end of the shackle pin. Do not reduce the width between the shackle jaws by welding washers or spacers to the inside of the shackle eyes or by narrowing the jaws, as this will affect the WLL of the shackle.

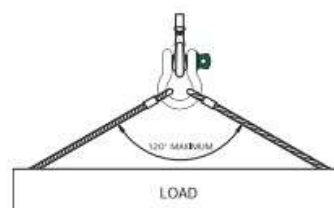

Utilizzare un grillo a omega per sostenere due bracci di fune. L'angolo al vertice non deve MAI superare i 120°. Prevedere riduzione della portata come indicato a pag. 44. Se il carico è simmetrico la portata del grillo non deve essere ridotta.

When a shackle is used to connect two slings to a hook, a bow type shackle must be used. The angle between the slings should not exceed 120°. Reduction factors must be taken into account as shown at page 44. If symmetrically loaded, the shackle may be used to the WLL.





Accessori per fune

Wire rope fittings

GRILLI AD OMEGA

Green Pin®

Green Pin® BOW SHACKLES

Perno filettato Screw pin	Dado coppiglia Safety bolt	Portata WLL	Misura Size	Dimensioni Dimensions											Peso Weight		
															G 4161 Kg	G 4163 Kg	
G 4161	G 4163	t	inches	a mm	b mm	c mm	d mm	e mm	f mm	g mm	h mm	i mm	i mm	j mm	k mm	G 4161 Kg	G 4163 Kg
AGRLVF00,3	-	0,33	3/16	5	6	12	5	9,5	22	16	36	29,5	-	26	-	0,02	-
AGRLVF005	AGRLVD005	0,5	1/4	7	8	16,5	7	12	29	20	48,5	38	42	34	4	0,05	0,06
AGRLVF007,5	AGRLVD007,5	0,75	5/16	9	10	20	9	13,5	32	22	56	46,5	50	40	5	0,1	0,11
AGRLVF01	AGRLVD01	1	3/8	10	11	22,5	10	17	36,5	26	63,5	54	61	46	8	0,14	0,16
AGRLVF01,5	AGRLVD01,5	1,5	7/16	11	13	26,5	11	19	43	29	74	59,5	68	51	11	0,19	0,22
AGRLVF02	AGRLVD02	2	1/2	13,5	16	34	13	22	51	32	89	73	83	58	13	0,36	0,42
AGRLVF03,2	AGRLVD03,2	3,25	5/8	16	19	40	16	27	64	43	110	89	99	75	17	0,63	0,74
AGRLVF04,7	AGRLVD04,7	4,75	3/4	19	22	46	19	31	76	51	129	103	115	89	19	1,01	1,18
AGRLVF06,5	AGRLVD06,5	6,5	7/8	22	25	52	22	36	83	58	144	119	131	102	22	1,5	1,77
AGRLVF08,5	AGRLVD08,5	8,5	1	25	28	59	25	43	95	68	164	137	151	118	25	2,21	2,58
AGRLVF09,5	AGRLVD09,5	9,5	1 1/8	28	32	66	28	47	108	75	185	153	167	131	27	3,16	3,66
AGRLVF12	AGRLVD12	12	1 1/4	32	35	72	32	51	115	83	201	170	179	147	30	4,31	4,91
AGRLVF13,5	AGRLVD13,5	13,5	1 3/8	35	38	80	35	57	133	92	227	186	198	162	33	5,55	6,54
AGRLVF17	AGRLVD17	17	1 1/2	38	42	88	38	60	146	99	249	203	203	175	19	7,43	8,19
AGRLVF25	AGRLVD25	25	1 3/4	45	50	103	45	74	178	126	300	243	244	216	23	12,84	14,22
AGRLVF35	AGRLVD35	35	2	50	57	111	50	83	197	138	331	272	270	238	26	18,15	19,85
AGRLVF42,5	AGRLVD42,5	42,5	2 1/4	57	65	130	57	95	222	160	377	310	302	274	29	26,3	28,33
AGRLVF55	AGRLVD55	55	2 1/2	65	70	145	65	105	260	180	433	344	330	310	32	37,6	39,59
-	AGRLVD85	85	3	75	83	163	75	127	329	190	527	-	376	355	39	-	62

- Coefficiente di sicurezza 6.
- Temperatura di lavoro: -40°C + 200°C.
- Safety factor 6.
- Temperature range: -40°C + 200°C.

Tipo G 4161

Con perno filettato
Acciaio alta resistenza gr. 6
Finitura: zincatura a caldo

G 4161 type

With screw pin
Gr. 6 high tensile steel
Finish: hot dip galvanized

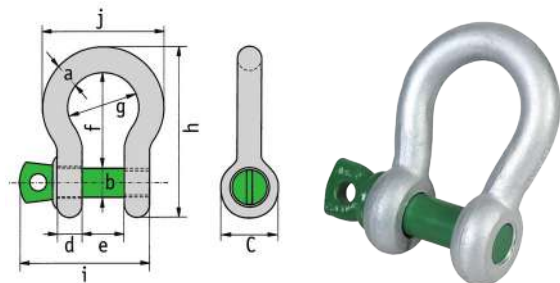

Tipo G 4163

Con dado e coppiglia
Acciaio alta resistenza gr. 6
Finitura: zincatura a caldo

G 4163

With safety bolt
Gr. 6 high tensile steel
Finish: hot dip galvanized

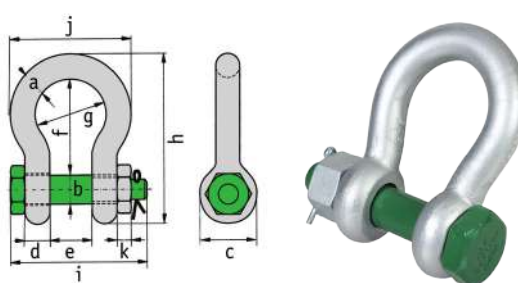



Accessori per fune

Wire rope fittings

GRILLI AD OMEGA

Green Pin®

Green Pin® BOW SHACKLES

Codice Code	Portata WLL	Dimensioni Dimensions											Peso Weight
		t	a mm	b mm	c mm	d mm	e mm	f mm	g mm	h mm	i mm	j mm	
P 6036	t	a	b	c	d	e	f	g	h	i	j	k	Kg
AGRLVD120	120	95	95	215	91	147	400	238	647	440	428	50	110
AGRLVD150	150	105	108	245	102	169	410	275	688	490	485	60	160
AGRLVD200	200	120	130	288	113	179	513	290	838	520	530	60	235
AGRLVD250	250	130	140	308	118	205	554	305	904	560	565	65	285
AGRLVD300	300	140	150	335	123	205	618	305	996	575	585	70	340
AGRLVD400	400	170	175	387	164	231	668	325	1114	690	665	70	560
AGRLVD500	500	180	185	410	1364	256	718	350	1190	720	710	70	685
AGRLVD600	600	200	205	458	189	282	718	375	1243	810	775	70	880
AGRLVD700	700	210	215	468	204	308	718	400	1263	870	820	70	980
AGRLVD800	800	210	220	478	204	308	718	400	1270	870	820	70	1100
AGRLVD900	900	220	230	500	215	328	718	420	1296	920	860	70	1280
AGRLVD1000	1000	240	240	530	215	349	718	420	1336	940	900	70	1460
AGRLVD1250	1250	260	270	600	230	369	768	450	1456	1025	970	70	1990
AGRLVD1500	1500	280	290	640	230	369	818	450	1556	1025	1010	70	2400

- Coefficiente di sicurezza 5.
- Temperatura di lavoro: da 120 t a 250 t: -20°C + 200°C.
da 300 t a 1500 t: -0°C + 200°C.
- Safety factor 5.
- Temperature range: from 120 t to 250 t: -20°C + 200°C.
from 300 t to 1500 t: -0°C + 200°C.

Tipo P 6036

Con dado e coppiglia

Acciaio alta resistenza gr. 8

Finitura: verniciati (120 t zincato a caldo)

P 6036 Type

With safety bolt

Gr. 8 high tensile steel

Finish: painted (120 t hot dip galvanized)

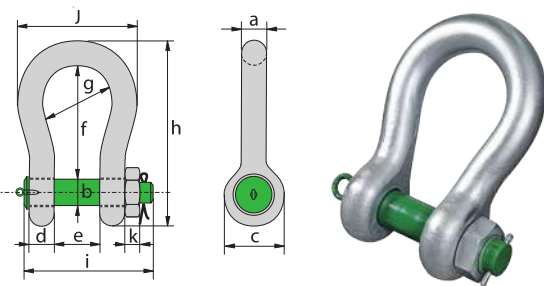



Accessori per fune

Wire rope fittings

GRILLI AD OMEGA

BOW SHACKLES

Perno filettato Screw pin	Dado coppiglia Safety bolt	Portata WLL	Misura Size	Dimensioni Dimensions					Peso Weight	
				A mm	B mm	C mm	D mm	L mm	GRL-OM Kg	GRL-OMD Kg
GRL-OM	GRL-OMD	t	inches							
AGRLOM 005	-	0,5	1/4	12	8	20	7	29	0,05	-
AGRLOM 007,5	-	0,75	5/16	13,5	10	21	9	32	0,1	-
AGRLOM 01	-	1	3/8	16,5	11,5	26	10	36,5	0,15	-
AGRLOM 01,5	AGRLOD 01,5	1,5	7/16	18,5	12	29	11	43	0,21	0,25
AGRLOM 02	AGRLOD 02	2	1/2	22	16	32	13,5	51	0,37	0,44
AGRLOM 03,2	AGRLOD 03,2	3,25	5/8	26	19	42	16	64	0,65	0,79
AGRLOM 04,7	AGRLOD 04,7	4,75	3/4	31	22	50	19	76	1,06	1,26
AGRLOM 06,5	AGRLOD 06,5	6,5	7/8	36	25	58	22	83	1,56	1,88
AGRLOM 08,5	AGRLOD 08,5	8,5	1	43	28	68	25	95	2,32	2,78
AGRLOM 09,5	AGRLOD 09,5	9,5	1 1/8	47	32	74	28	108	3,28	3,87
AGRLOM 12	AGRLOD 12	12	1 1/4	52	35	83	32	115	4,51	5,26
AGRLOM 13,5	AGRLOD 13,5	13,5	1 3/8	57	38	92	35	133	5,93	6,94
AGRLOM 17	AGRLOD 17	17	1 1/2	61	41	98	38	146	7,89	8,79
AGRLOM 25	AGRLOD 25	25	1 3/4	73	51	126	45	178	13,40	15,00
-	AGRLOD 35	35	2	83	57	138	50	197	-	20,65
-	AGRLOD 55	55	2 1/2	105	70	180	65	260	-	41,05

- Coefficiente di sicurezza 6.
- Temperatura di lavoro: -20°C + 200°C.
- Safety factor 6.
- Temperature range: -20°C + 200°C.

Tipo GRL-OM

Con perno filettato
Acciaio alta resistenza gr. 6
Finitura: zincatura a caldo

GRL-OM Type

With screw pin
Gr. 6 high tensile steel
Finish: hot dip galvanized

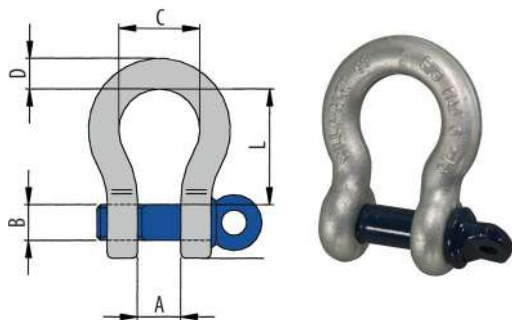

Tipo GRL-OMD

Con dado e coppiglia
Acciaio alta resistenza gr. 6
Finitura: zincatura a caldo

GRL-OMD Type

With safety bolt
Gr. 6 high tensile steel
Finish: hot dip galvanized

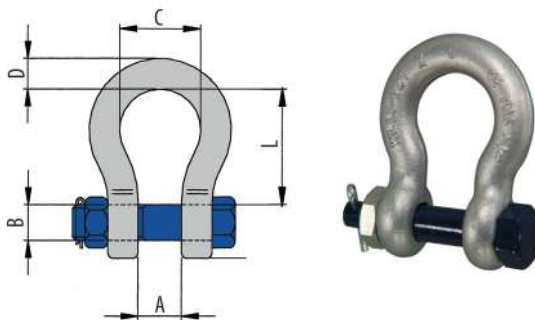



Accessori per fune

Wire rope fittings

GRILLI AD OMEGA

Green Pin® “SUPER”

Green Pin® “SUPER” BOW SHACKLES

Perno filettato Screw pin	Codice Code	Dado coppiglia Safety bolt	Portata WLL	Dimensioni Dimensions											Peso Weight			
				t	a mm	b mm	c mm	d mm	e mm	f mm	g mm	h mm	G 5261 i mm	G 5263 i mm	j mm	k mm	G 5261 Kg	G 5263 Kg
G 5261	G 5263																	
AGRLVF8 003	AGRLV8 003		3,3	13,5	16	34	13	22	51	32	89	73	82	58	13	0,36	0,44	
AGRLVF8 005	AGRLV8 005		5	16	19	40	16	27	64	43	110	89	98	75	17	0,63	0,79	
AGRLVF8 007	AGRLV8 007		7	19	22	46	19	31	76	51	129	103	114	89	19	1,01	1,26	
AGRLVF8 009	AGRLV8 009		9,5	22	25	52	22	36	83	58	144	119	130	102	22	1,50	1,88	
AGRLVF8 012	AGRLV8 012		12,5	25	28	59	25	43	95	68	164	137	150	118	25	2,21	2,78	
AGRLVF8 015	AGRLV8 015		15	28	32	66	28	47	108	75	185	153	166	131	27	3,16	3,87	
AGRLVF8 018	AGRLV8 018		18	32	35	72	32	51	115	83	201	170	178	147	30	4,31	5,26	
AGRLVF8 021	AGRLV8 021		21	35	38	80	35	57	133	92	227	186	197	162	33	5,58	6,94	
AGRLVF8 030	AGRLV8 030		30	38	42	88	38	60	146	99	249	203	217	175	19	7,47	8,79	
AGRLVF8 040	AGRLV8 040		40	45	50	103	45	74	178	126	300	243	249	216	23	12,5	15	
AGRLVF8 055	AGRLV8 055		55	57	57	117	57	83	197	138	341	286	286	252	26	17,2	24	
AGRLVF8 085	AGRLV8 085		85	70	70	143	70	105	260	180	437	354	344	320	32	37,6	45	
-	AGRLV8 120		120	83	83	162	83	127	329	190	535	-	403	356	40	-	72	
-	AGRLV8 150		150	95	95	208	91	147	400	238	647	-	511	428	50	-	112	
-	AGRLV8 175		175	105	108	238	102	169	410	275	688	-	561	485	60	-	160	

- Coefficiente di sicurezza 5.
- Temperatura di lavoro: -20°C + 200°C.
- Safety factor 5.
- Temperature range: -20°C + 200°C.

Steel alloy shackles grade 8 quenched and tempered. Compared to standard shackles they have an up to 50% higher WLL with comparable weight and dimensions.

Grilli in acciaio legato grado 8 bonificati. La caratteristica costruttiva di questi grilli consente di avere portate fino al 50% superiori rispetto ai grilli standard paragonabili come peso e dimensioni.

Tipo G 5261 “SUPER”

Con perno filettato
Acciaio alta resistenza gr. 8
Finitura: zincatura a caldo

G 5261 “SUPER” type
With screw pin
Gr. 8 high tensile steel
Finish: hot dip galvanized

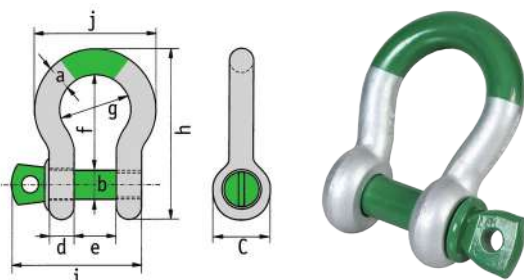

Tipo G 5263 “SUPER”

Con dado e coppiglia
Acciaio alta resistenza gr. 8
Finitura: zincatura a caldo (175t verniciato)

G 5263 “SUPER” type
With safety bolt
Gr. 8 high tensile steel
Finish: hot dip galvanized (175t shackle painted)

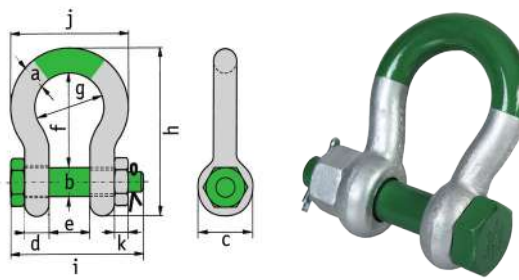



Accessori per fune

Wire rope fittings

GRILLI AD OMEGA

Green Pin® "POLAR"

Green Pin® "POLAR" BOW SHACKLES

Codice Code	Portata WLL	Dimensioni Dimensions											Peso Weight	
		t	a mm	b mm	c mm	d mm	e mm	f mm	g mm	h mm	i mm	j mm		k mm
G 5163														
AGRLVP 02	2	13,5	16	34	13	22	51	32	89	82	58	13	0,42	
AGRLVP 03,2	3,25	16	19	40	16	27	64	43	110	98	75	17	0,74	
AGRLVP 04,7	4,75	19	22	46	19	31	76	51	129	114	89	19	1,18	
AGRLVP 06,5	6,5	22	25	52	22	36	83	58	144	130	102	22	1,77	
AGRLVP 08,5	8,5	25	28	59	25	43	95	68	164	150	118	25	2,58	
AGRLVP 09,5	9,5	28	32	66	28	47	108	75	185	166	131	27	3,66	
AGRLVP 12	12	32	35	72	32	51	115	83	201	178	147	30	4,91	
AGRLVP 13,5	13,5	35	38	80	35	57	133	92	227	197	162	33	6,54	
AGRLVP 17	17	38	42	88	38	60	146	99	249	202	175	19	8,19	
AGRLVP 25	25	45	50	103	45	74	178	126	300	249	216	23	14,22	
AGRLVP 35	35	50	57	116	50	83	197	138	334	269	238	26	19,85	
AGRLVP 42,5	42,5	57	65	130	57	95	222	160	377	301	274	29	28,33	
AGRLVP 55	55	65	70	145	65	105	260	180	433	330	310	32	39,59	
AGRLVP 85	85	75	83	162	73	127	329	190	527	380	340	39	62	

- Coefficiente di sicurezza 7 (55 t e 85 t coeff. 6) / Temperatura di lavoro: -60°C + 200°C
- Safety factor 7 (55 t and 85 t factor 6) / Operating temperature: -60°C + 200°C

Codice Code	Portata WLL	Dimensioni Dimensions											Peso Weight
		t	a mm	b mm	c mm	d mm	e mm	f mm	g mm	h mm	i mm	j mm	
P 6031													
AGRLVP 120	120	95	95	208	91	147	400	238	647	440	428	50	110
AGRLVP 150	150	105	108	238	102	167	410	275	688	490	485	60	160
AGRLVP 200	200	120	130	279	113	179	513	290	838	520	530	60	235
AGRLVP 250	250	130	140	299	118	205	554	305	904	560	565	65	285
AGRLVP 300	300	140	150	325	123	205	618	305	996	575	585	70	340
AGRLVP 400	400	170	175	376	164	231	668	325	1114	690	665	70	560
AGRLVP 500	500	180	185	398	164	256	718	350	1190	720	710	70	685
AGRLVP 600	600	200	205	444	189	282	718	375	1243	810	775	70	880
AGRLVP 700	700	210	215	454	204	308	718	400	1263	870	820	70	980
AGRLVP 800	800	210	220	464	204	308	718	400	1270	870	820	70	1100
AGRLVP 900	900	220	230	485	215	328	718	420	1296	920	860	70	1280
AGRLVP 1000	1000	240	240	515	215	349	718	420	1336	940	900	70	1460

- Coefficiente di sicurezza 5 / Temperatura di lavoro: -40°C + 200°C
- Safety factor 5 / Operating temperature: -40°C + 200°C

Tipo G 5163 "POLAR"

Con dado e coppiglia
Acciaio alta resistenza gr. 8
Finitura: zincatura a caldo

G 5163 "POLAR" type

With safety bolt
Gr. 8 high tensile steel
Finish: hot dip galvanized

Tipo P 6031 "POLAR"

Con dado e coppiglia
Acciaio alta resistenza gr. 8
Finitura: verniciati (120 t zincato a caldo)

P 6031 "POLAR" type

With safety bolt
Gr. 8 high tensile steel
Finish: painted (120 t hot dip galvanized)

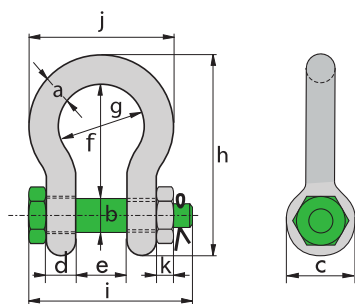



Accessori per fune

Wire rope fittings

GRILLI AD OMEGA

Green Pin® "ROV"

Green Pin® "ROV" BOW SHACKLES

ROV shackles are suitable for subsea use and operation by a Remote Operated Vehicle.

For the purpose of operating lifting equipment the Remote Operated Vehicle is fitted with a hydraulically controlled arm to safely release or retrieve heavy equipment under water.

Based on the purpose of the shackle a certain design can only release the load, only retrieve the load or the shackle can do both.

Green Pin ROV Shackles available:

- P 5363 Release Spring Shackle
- P 5365 Spring Locking Clamp Shackle
- P 5367 Spring Release Shackle
- P 5361 D Release and Retrieve shackle with D-handle
- P 5361 F Release and Retrieve shackle with F-handle
- P 5362 D Release and Retrieve shackle with D-handle and guided pin
- P 5362 F Release and Retrieve shackle with F-handle and guided pin

I grilli ROV sono stati realizzati per impiego sott'acqua tramite comando remoto.

Il robot (Remote Operated Vehicle) comandato a distanza è dotato di braccio idraulico con cui smontare e rimontare in sicurezza i grilli sott'acqua.

Alcuni grilli sono previsti per il solo rilascio del perno, altri invece consentono anche il riassetaggio.

Grilli a omega Green Pin ROV disponibili:

- P 5363 Con coppiglie
- P 5365 Con morsa di serraggio
- P 5367 Con molla caricata
- P 5361 D Con impugnatura D
- P 5361 F Con impugnatura F
- P 5362 D Con impugnatura D e perno guidato
- P 5362 F Con impugnatura F e perno guidato

Caratteristiche e dati tecnici www.fasitaly.com
Specifications and technical data at www.fasitaly.com



P 5363
Con coppiglie di sicurezza
With spring pins



P 5365
Con morsa di serraggio
With locking clamps



P 5367
Con molla caricata
Spring loaded



P 5361 D
Con impugnatura D
With D-handle



P 5361 F
Con impugnatura F
With F-handle



P 5362 D
Con impugnatura D
e perno guidato
With D-handle and guided pin



Accessori per fune

Wire rope fittings

GRILLI AD OMEGA

Green Pin® "A BOCCA LARGA"

Green Pin® "WIDE MOUTH" BOW SHACKLES

Tipo G 4263

Con dado e coppiglia
Acciaio alta resistenza gr. 8
Finitura: zincatura a caldo

G 4263 type

With safety bolt
Gr. 8 high tensile steel
Finish: hot dip galvanized

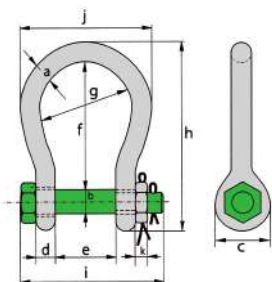

Codice Code	Portata WLL	Dimensioni Dimensions											Peso Weight	
		t	a mm	b mm	c mm	d mm	e mm	f mm	g mm	h mm	i mm	j mm		k mm
G 4263														
AGRLVL04,75	4,75	22	25	52	22	63	112	88	173	157	132	22	2,08	
AGRLVL06,5	6,5	25	28	59	25	75	135	105	204	183	155	25	3,14	
AGRLVL08,5	8,5	28	32	66	28	82	148	115	225	205	171	27	4,35	
AGRLVL09,5	9,5	32	35	72	32	90	162	126	248	224	190	30	5,95	
AGRLVL12	12	35	38	79	35	100	180	140	274	245	210	33	7,87	
AGRLVL16	16	38	42	88	38	106	216	159	319	248	235	19	12,5	
AGRLVL25	25	45	50	103	45	127	248	175	370	296	265	23	16,7	
AGRLVL30	30	50	57	118	50	146	273	207	411	332	307	26	25	
AGRLVL55	55	65	70	145	65	165	314	213	487	389	343	32	45	
AGRLVL75	75	83	83	163	83	184	330	254	537	460	420	39	70	

- Coefficiente di sicurezza 6.
- Temperatura di lavoro: -20°C ÷ 200°C.
- Safety factor 6.
- Temperature range: -20°C ÷ 200°C..



Disponibili con portate da 4,75 t a 75 t, questi grilli sono caratterizzati dalla larga apertura della staffa a fronte del diametro del perno relativamente piccolo.

Available with WLL from 4,75 ton up to 75 ton, these shackles combine a large opening with a relatively small pin diameter.





Accessori per fune

Wire rope fittings

GRILLI DIRITTI

Green Pin® “A BOCCA LARGA”

Green Pin® “WIDE MOUTH” DEE SHACKLES

Codice Code	Portata WLL	Dimensioni Dimensions									Peso Weight
		a mm	b mm	c mm	d mm	e mm	f mm	g mm	h mm	i mm	
G 4553	t										Kg
AGRUVL04,6	4,6	19	22	46	19	70	116	169	154	19	1,50
AGRUVL08,6	8,6	25	28	59	25	83	140	208	190	25	3,15
AGRUVL15,5	15,5	38	42	88	38	115	178	281	257	19	9,50

- Coefficiente di sicurezza 5.
- Temperatura di lavoro: -20°C + 200°C.
- Safety factor 5.
- Temperature range: -20°C + 200°C.

Tipo G 4553

Con dado e coppiglia
Acciaio alta resistenza gr. 8
Finitura: zincatura a caldo

G 4553 type

With safety bolt
Gr. 8 high tensile steel
Finish: hot dip galvanized

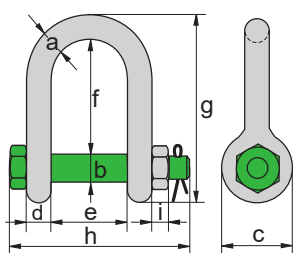



Accessori per fune

Wire rope fittings

GRILLI AD OMEGA

Green Pin® "SLING"

Green Pin® "SLING"
BOW SHACKLES

Codice Code	Portata WLL	Dimensioni Dimensions												Peso Weight
		t	a mm	b mm	c mm	d mm	e mm	f mm	g mm	h mm	i mm	J mm	k mm	
P 6033														
AGRLVS0007	7	22	22	46	19	32	96	64	153	115	110	19	41	2
AGRLVS0012,5	12,5	28	28	61	25	44	121	82	197	151	146	24	54	4
AGRLVS0018	18	35	35	69	30	52	147	102	239	165	180	29	64	7
AGRLVS0030	30	40	42	90	35	69	165	126	279	207	200	34	79	13
AGRLVS0040	40	55	51	109	45	84	200	140	331	252	235	38	97	21
AGRLVS0055	55	60	57	115	55	90	240	160	389	294	270	45	100	30
AGRLVS0075	75	68	70	125	54	110	290	185	473	327	317	54	120	48
AGRLVS0125	125	85	80	154	85	137	366	220	583	426	390	64	150	92
AGRLVS0150	150	94	95	179	89	147	391	253	645	435	434	50	170	140
AGRLVS0200	200	110	105	199	100	158	481	280	759	470	482	50	205	205
AGRLVS0250	250	126	120	227	110	179	542	300	859	519	530	60	240	264
AGRLVS0300	300	135	134	245	122	195	601	350	947	575	620	70	265	360
AGRLVS0400	400	160	160	293	145	231	576	370	985	675	690	80	320	580
AGRLVS0500	500	170	180	328	160	263	681	450	1131	748	790	90	340	780
AGRLVS0600	600	190	200	348	170	289	741	490	1234	809	865	100	370	980
AGRLVS0700	700	200	215	392	190	315	751	540	1284	879	901	100	400	1360
AGRLVS0800	800	218	230	420	200	342	851	554	1426	942	947	110	420	1430
AGRLVS0900	900	242	255	466	220	368	851	580	1488	1023	1023	120	440	1650
AGRLVS1000	1000	260	270	490	240	399	851	614	1532	1103	1107	120	460	2970
AGRLVS1250	1250	285	300	510	260	452	931	650	1666	1227	1182	150	530	3700
AGRLVS1500	1500	285	320	550	280	483	950	680	1710	1300	1253	150	560	4000

- Coefficiente di sicurezza 5.
- Temperatura di lavoro: -20°C + 200°C.
- Safety factor 5.
- Temperature range: -20°C + 200°C.

- Migliora notevolmente la vita delle brache in fune metallica.
- L'aumento del raggio della sella del grillo permette l'aumento della superficie di appoggio della fune senza necessità di una redancia.
- Rispetto al grillo tradizionale riduce la perdita di portata dovuta all'avvolgimento delle funi su curvature di piccolo raggio.
- Wire rope life strongly improved.
- As the bending curve is larger compared to a standard shackle, the wire rope has a larger radius and a thimble is not need.
- Lower decrease of capacity compared to a standard shackle, as the bending curve is larger.

Tipo P 6033 SLING

Con dado e coppiglia
Acciaio alta resistenza gr. 8
Finitura: da 7t a 55t zincatura a caldo
>55t verniciati

P 6033 SLING type

With safety bolt
Gr. 8 high tensile steel
Finish: from 7t to 55t hot dip galvanized
>55t painted

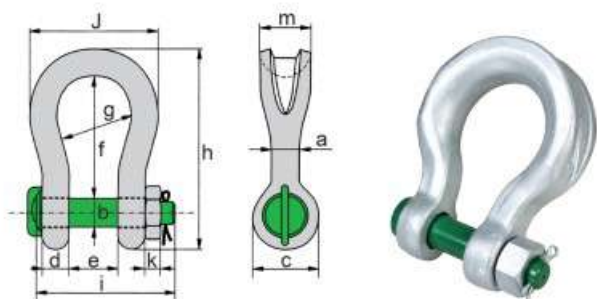



Accessori per fune

Wire rope fittings

GRILLI AD OMEGA

Green Pin® "POWER SLING"

Green Pin® "POWER SLING"
BOW SHACKLES

Codice Code	Portata WLL	Dimensioni Dimensions											Peso Weight	
		t	b mm	c mm	d mm	e mm	f mm	g mm	h mm	i mm	J mm	k mm		m mm
P 6043														
AGRLVPS0125	125	80	166	85	134	364	220	631	382	370	36	205	95	
AGRLVPS0150	150	95	182	90	144	389	250	703	408	420	42	248	134	
AGRLVPS0200	200	105	204	100	154	479	276	838	446	475	47	290	195	
AGRLVPS0250	250	120	238	110	174	539	300	938	503	515	60	314	271	
AGRLVPS0300	300	134	260	121	189	599	350	1031	550	605	60	345	368	
AGRLVPS0400	400	160	305	140	224	620	370	1123	645	652	80	392	563	
AGRLVPS0500	500	180	340	152	255	679	450	1239	714	763	85	440	786	
AGRLVPS0600	600	200	365	170	280	739	490	1353	788	820	90	475	1009	
AGRLVPS0700	700	215	405	190	320	750	540	1415	879	895	100	512	1288	
AGRLVPS0800	800	230	430	200	347	850	554	1547	942	917	108	536	1503	
AGRLVPS0900	900	255	476	215	373	850	580	1598	1013	970	120	560	1849	
AGRLVPS1000	1000	270	500	232	404	850	614	1642	1085	1022	125	590	2188	
AGRLVPS1250	1250	300	570	245	442	928	650	1812	1164	1144	140	670	2933	
AGRLVPS1550	1550	320	590	270	475	950	680	1890	1231	1280	196	704	3558	

- Coefficiente di sicurezza 5.
- Temperatura di lavoro: -40°C + 200°C.
- Safety factor 5.
- Temperature range: -40°C + 200°C.

- The Green Pin Power Sling Shackle lets you save significant amount on synthetic and wire rope sling costs thanks to the optimal D/d ratio and the widest crown (+10%) in the industry.
- Each shackle has been individually proofload tested to twice the WLL and material characteristics have been thoroughly examined by MPI tests., ultrasonic inspection and X-ray tests.
- The Power sling shackle also offers riggers great handling thanks to the lowest body weight and the multiple handling points.

- I grilli Power Sling consentono risparmi significativi sui costi delle imbragature in fune d'acciaio o di fibre sintetiche grazie al rapporto ottimizzato tra i diametri coinvolti D/d e alla larghezza maggiorata della parte superiore del grillo.
- I grilli sono testati individualmente al doppio della portata e tutte le caratteristiche dei materiali vengono esaminate con test MPI, ultrasuoni e raggi X.
- Il peso diminuito e i punti di aggancio facilitano la movimentazione dei grilli.

Tipo P 6043 POWER SLING

Con dado e coppiglia

Acciaio alta resistenza G8

Finitura: corpo verniciato argento; perno verniciato verde

P 6043 POWER SLING type

With safety bolt

G8 High tensile steel

Finish: body silver painted; pin green painted

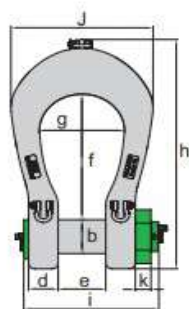



Accessori per fune

Wire rope fittings

GRILLI Green Pin® ANTI-SVITAMENTO

Green Pin® FIXED NUT SHACKLES

Shackles can also be used in more permanent construction. These can be subject to dynamic loads and/or extreme vibrations. In such applications there is a risk that, over time, the nut starts moving over the thread. To avoid this risk we offer our range of Green Pin fixed nut shackles. Green Pin standard, Polar, Super, Sling and Wide Mouth shackles can be equipped with an extra AISI 316 securing bolt which is drilled through the nut and shackle pin. This securing bolt is fastened with two sets of special washers and a securing nut. This will keep the shackle nut in position. The wedge locking washers lock when subjected to extreme vibration or dynamic loads. Green Pin Fixed Nut Shackles are available on request.

Green Pin Fixed Nut Shackles available:

- **G 4143 Standard bow shackles**
See dimensions of shackles G 4163 at page 46
- **P 6016 Heavy duty bow shackles**
See dimensions of shackles P 6036 at page 47
- **G 4133 Standard U shackles**
See dimensions of shackles G 4153 at page 58
- **G 6018 Heavy duty U shackles**
Dimensions on request
- **G 5143 Polar shackles**
See dimensions of shackles G 5163 at page 50
- **P 6011 Polar Heavy duty shackles**
Dimensions on request
- **G 5243 Super shackles**
See dimensions of shackles G 5263 at page 49
- **P 6013 Sling shackles**
See dimensions of shackles P 6033 at page 54
- **G 4243 "Wide mouth" shackles**
See dimensions of shackles G 4263 at page 52

I grilli vengono utilizzati anche per applicazioni permanenti e possono essere soggetti a carichi dinamici e/o forti vibrazioni. In questi casi esiste il rischio che nel tempo il dado cominci a muoversi sul filetto. Per evitare questo rischio, consigliamo l'impiego di grilli con dado anti svitamento.

I grilli Green Pin standard, Polar, Super, Sling e a Bocca Larga possono essere forniti con un bullone di acciaio inossidabile AISI 316 passante attraverso il dado ed il perno del grillo. Il bullone viene fissato con due rondelle speciali ed un dado di sicurezza.

Le rondelle autobloccanti si bloccano quando sono soggette a vibrazioni forti o carichi dinamici.

Grilli Anti-svitamento disponibili:

- **G 4143 Grilli Standard ad omega**
Vedere dimensioni dei grilli G 4163 a pag. 46
- **P 6016 Grilli Heavy duty a omega**
Vedere dimensioni dei grilli P 6036 a pag. 47
- **G 4133 Grilli Standard ad U**
Vedere dimensioni dei grilli G 4153 a pag. 58
- **G 6018 Grilli Heavy duty ad U**
Dimensioni su richiesta
- **G 5143 Grilli Polar**
Vedere dimensioni dei grilli G 5163 a pag. 50
- **P 6011 Grilli Polar Heavy duty**
Dimensioni su richiesta
- **G 5243 Grilli Super**
Vedere dimensioni dei grilli G 5263 a pag. 49
- **P 6013 Grilli Sling**
Vedere dimensioni dei grilli P 6033 a pag. 54
- **G 4243 Grilli a bocca larga**
Vedere dimensioni dei grilli G 4263 a pag. 52

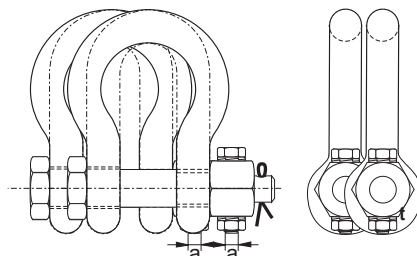

G 4143



P 6016



G 4133



G 6018



G 5143



P 6011



G 5243



G 4243



Accessori per fune

Wire rope fittings

GRILLI Green Pin® ANTI-SVITAMENTO

Green Pin® FIXED NUT SHACKLES

Portata WLL	Portata WLL	Portata WLL	Portata WLL	Portata WLL	Portata WLL	Portata WLL	Portata WLL	Portata WLL	Dimensioni Dimensions	Coppia Torque
G 4143	P 6016	G 4133	G 6018	G 5143	P 6011	G 5243	P 6013	G 4243	a	Nm
t	t	t	t	t	t	t	t	t		
2		2		2		3,3			M6	8,4
3,25		3,25		3,25		5			M6	8,4
4,75		4,75		4,75		7	7		M6	8,4
6,5		6,5		6,5		9,5		4,75	M8	20
8,5		8,5		8,5		12,5	12,5	6,5	M8	20
9,5		9,5		9,5		15		8,5	M10	39
12		12		12		18	18	9,5	M10	39
13,5		13,5		13,5		21		12	M10	39
							30		M6	8,4
17		17		17		30		16	M8	20
25		25		25		40	40	25	M8	20
35		35		35		55	55	30	M10	39
42,5		42,5		42,5					M12	68
55		55		55				55	M12	68
85		85		85		85	75	75	M12	68
	120		120		120	120	125		M12	68
	150		150		150	150	150		M12	68

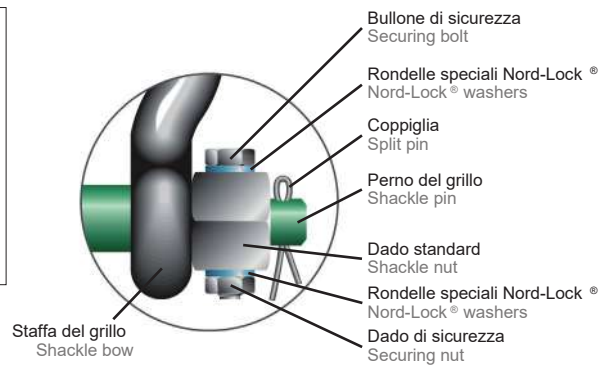



Accessori per fune

Wire rope fittings

GRILLI "DRITTI" Green Pin®

Green Pin® "DEE" SHACKLES

Codice Code	Portata WLL	Misura Size	Dimensioni Dimensions										Peso Weight			
			t	inches	a mm	b mm	c mm	d mm	e mm	f mm	g mm	G 4151 h mm	G 4153 h mm	j mm	GRL-U Kg	GRL-UD Kg
G 4151																
	G 4153															
AGRUVF 01	-	1	3/8	10	11	22,5	10	17	32	59	54	-	-	0,14	-	
AGRUVF 01,5	-	1,5	7/16	11	13	26,5	11	19	37	68	59,5	-	-	0,19	-	
AGRUVF 02	AGRUVD 02	2	1/2	13,5	16	34	13	22	43	81	73	82	13	0,32	0,39	
AGRUVF 03,2	AGRUVD 03,2	3,25	5/8	16	19	40	16	27	51	97	89	98	17	0,54	0,67	
AGRUVF 04,7	AGRUVD 04,7	4,75	3/4	19	22	46	19	31	59	112	103	114	19	0,87	1,08	
AGRUVF 06,5	AGRUVD 06,5	6,5	7/8	22	25	52	22	36	73	134	119	130	22	1,34	1,66	
AGRUVF 08,5	AGRUVD 08,5	8,5	1	25	28	59	25	43	85	154	137	150	25	2,08	2,46	
AGRUVF 09,5	AGRUVD 09,5	9,5	1 1/8	28	32	66	28	47	90	167	153	166	27	2,77	3,4	
AGRUVF 12	AGRUVD 12	12	1 1/4	32	35	72	32	51	94	180	170	178	30	3,72	4,51	
AGRUVF 13,5	AGRUVD 13,5	13,5	1 3/8	35	38	80	35	57	115	209	186	197	33	5,14	6,1	
AGRUVF 17	AGRUVD 17	17	1 1/2	38	42	88	38	60	127	230	203	202	19	6,85	7,63	
AGRUVF 25	AGRUVD 25	25	1 3/4	45	50	103	45	74	149	271	243	249	23	11,45	13,25	
AGRUVF 35	AGRUVD 35	35	2	50	57	111	50	83	171	305	272	269	26	16,86	18,53	
AGRUVF 42,5	AGRUVD 42,5	42,5	2 1/4	57	65	130	57	95	190	345	310	301	29	24,61	25,94	
AGRUVF 55	AGRUVD 55	55	2 1/2	65	70	145	65	105	203	376	344	330	32	32,65	35,33	
-	AGRUVD 85	85	3	75	83	162	73	127	229	427	-	380	39	-	52,97	

- Coefficiente di sicurezza 6.
- Temperatura di utilizzo: -40°C ÷ 200°C.
- Safety factor 6.
- Temperature range: -40°C ÷ 200°C.

Tipo G 4151

Con perno filettato
Acciaio alta resistenza gr. 6
Finitura: zincatura a caldo

G 4151 type

With screw pin
Gr. 6 high tensile steel
Finish: hot dip galvanized

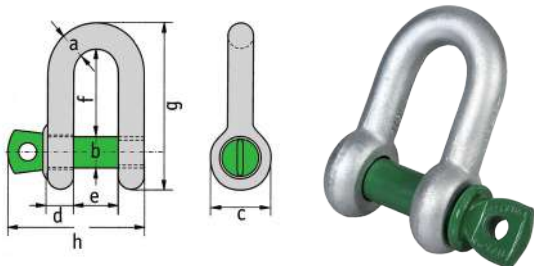

Tipo G 4153

Con dado e coppiglia
Acciaio alta resistenza gr. 6
Finitura: zincatura a caldo

G 4153 type

With safety bolt
Gr. 6 high tensile steel
Finish: hot dip galvanized

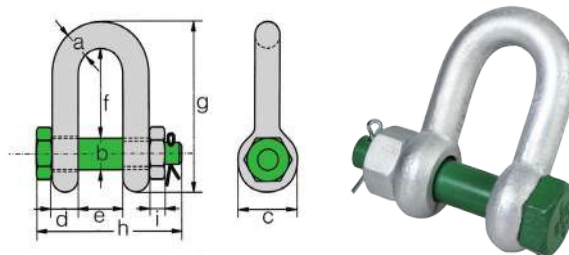



Accessori per fune

Wire rope fittings

GRILLI A OMEGA NERI Green Pin®

Green Pin® THEATRE SHACKLES

The Green Pin standard bow shackle with screw collar pins are now also available as a black painted "Theatre" type.
The theatre shackles are specially developed for the use in theatres to securely hang rigging and other accessories. Because of the black matt finish, the shackles will be hardly visible, even when they are in the spotlight.

I grilli ad omega Green Pin standard con perno filettato sono adesso disponibili anche verniciati di nero.

Questi grilli sono stati realizzati per utilizzo in teatro o su palcoscenici per sostenere in sicurezza i rigging e altri accessori.

Il colore nero opaco li rende poco visibili anche sotto le luci dei proiettori.

Codice Code	Portata WLL t	Dimensioni Dimensions										Peso Weight Kg
		a mm	b mm	c mm	d mm	e mm	f mm	g mm	h mm	i mm	j mm	
AGRLVFT00,3	0,33	5	6	12	5	9,5	22	16	36	29,5	26	0,02
AGRLVFT00,5	0,5	7	8	16,5	7	12	29	20	48,5	38	34	0,05
AGRLVFT00,7	0,75	9	10	20	9	13,5	32	22	56	46,5	40	0,10
AGRLVFT01	1	10	11	22,5	10	17	36,5	26	63,5	54	46	0,14
AGRLVFT01,5	1,5	11	13	26,5	11	19	43	29	74	59,5	51	0,19
AGRLVFT02	2	13,5	16	34	13	22	51	32	89	73	58	0,36
AGRLVFT03,2	3,25	16	19	40	16	27	64	43	110	89	75	0,63
AGRLVFT04,7	4,75	19	22	46	19	31	76	51	129	103	89	1,01
AGRLVFT06,5	6,5	22	25	52	22	36	83	58	144	119	102	1,50
AGRLVFT08,5	8,5	25	28	59	25	43	95	68	164	137	118	2,21

Tipo P 4161T

Con perno filettato

Acciaio alta resistenza gr. 6

Finitura: verniciati nero opaco RAL 7021

Temperatura di impiego: -40°C + 200°C

P 4161T type

With screw pin

Gr. 6 high tensile steel

Finish: painted black matt RAL 7021

Temperature range: -40°C + 200°C

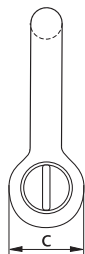
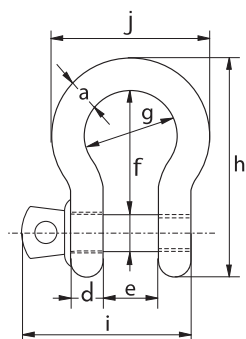



Accessori per fune

Wire rope fittings

GRILLI Green Pin® FISHING SQ

Green Pin® Fishing SQ
BOW AND DEE SHACKLES

Grilli ad omega Green Pin® Fishing SQ con perno con testa quadrata

Green Pin® Fishing SQ Bow Shackles with square headed screw pin

Tipo G 4164

Con perno filettato
Acciaio alta resistenza gr. 6
Finitura: zincatura a caldo

G 4164 type

With screw pin
Gr. 6 high tensile steel
Finish: hot dipped galvanized

Codice Code	Portata WLL t	Dimensioni Dimensions											Peso Weight Kg
		a mm	b mm	c mm	d mm	e mm	f mm	g mm	h mm	i mm	j mm	k mm	
AGRLVSQ02	2	13,5	16	35	13	22	51	32	89	57,5	58	22	0,34
AGRLVSQ03,2	3,25	16	19	40	16	27	64	43	110	71	75	27	0,63
AGRLVSQ04,7	4,75	19	22	46	19	31	76	51	129	82	89	32	1
AGRLVSQ06,5	6,5	22	25	52	22	36	83	58	144	93	102	32	1,44
AGRLVSQ08,5	8,5	25	28	59	25	43	95	68	164	108	118	36	2,21
AGRLVSQ09,5	9,5	28	32	66	28	47	108	75	185	120	131	41	3,18
AGRLVSQ12	12	32	35	72	32	51	115	83	201	137	147	50	4,32
AGRLVSQ13,5	13,5	35	38	80	35	57	133	92	227	149	162	50	5,67
AGRLVSQ17	17	38	42	88	38	60	146	99	249	164	175	60	7,36
AGRLVSQ25	25	45	50	103	45	74	178	126	300	192	216	60	12,38

- Coefficiente di sicurezza 6.
- Safety factor 6.

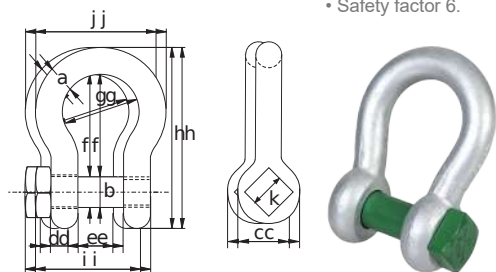

Grilli dritti Green Pin® Fishing SQ con perno con testa quadrata

Green Pin® Fishing SQ Dee Shackles with square headed screw pin

Tipo G 4154

Con perno filettato
Acciaio alta resistenza gr. 6
Finitura: zincatura a caldo

G 4154 type

With screw pin
Gr. 6 high tensile steel
Finish: hot dipped galvanized

Codice Code	Portata WLL t	Dimensioni Dimensions										Peso Weight Kg
		a mm	b mm	c mm	d mm	e mm	f mm	g mm	h mm	i mm		
AGRUVSQ02	2	13,5	16	34	13	22	43	81	57,5	22	0,32	
AGRUVSQ03,2	3,25	16	19	40	16	27	51	97	71	27	0,58	
AGRUVSQ04,7	4,75	19	22	46	19	31	59	112	82	32	0,92	
AGRUVSQ06,5	6,5	22	25	52	22	36	73	134	93	32	1,33	
AGRUVSQ08,5	8,5	25	28	59	25	43	85	154	108	36	2,03	
AGRUVSQ09,5	9,5	28	32	66	28	47	90	167	120	41	2,88	
AGRUVSQ12	12	32	35	72	32	51	94	180	137	50	3,96	
AGRUVSQ13,5	13,5	35	38	80	35	57	115	209	149	50	5,24	
AGRUVSQ17	17	38	42	88	38	60	127	230	164	60	6,8	
AGRUVSQ25	25	45	50	103	45	74	149	271	192	60	11,22	

- Coefficiente di sicurezza 6.
- Safety factor 6.

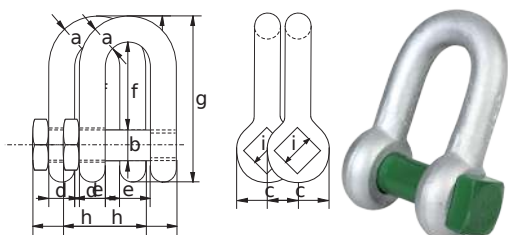



Accessori per fune

Wire rope fittings

GRILLI Green Pin® FISHING FP

Green Pin® Fishing FP
BOW AND DEE SHACKLES

Grilli ad omega Green Pin® Fishing FP con perno con foro quadrato incassato

Green Pir® Fishing FP Bow Shackles with square sunken hole screw pin (flush pin)

Senza parti sporgenti che potrebbero rovinare le reti

Tipo G 4169

Con perno filettato

Acciaio alta resistenza gr. 6

Finitura: zincatura a caldo

No protruding parts so does not damage the nets

G 4169 type

With screw pin

Gr. 6 high tensile steel

Finish: hot dipped galvanized

Codice Code	Portata WLL t	Dimensioni Dimensions											Peso Weight Kg
		a mm	b mm	c mm	d mm	e mm	f mm	g mm	h mm	i mm	j mm	k mm	
AGRLVFP02	2	13,5	16	34	13	22	51	32	89	51	58	11	0,31
AGRLVFP03,2	3,25	16	19	40	16	27	64	43	110	63	75	11	0,56
AGRLVFP04,7	4,75	19	22	46	19	31	76	51	129	74	89	11	0,98
AGRLVFP06,5	6,5	22	25	52	22	36	83	58	144	85	102	13	1,46
AGRLVFP08,5	8,5	25	28	59	25	43	95	68	164	99	118	13	2,18
AGRLVFP09,5	9,5	28	32	66	28	47	108	75	185	110	131	17	3,06
AGRLVFP12	12	32	35	72	32	51	115	83	201	122	147	17	4,24
AGRLVFP17	17	38	42	88	38	60	146	99	249	145	175	17	7,37

- Coefficiente di sicurezza 6.
- Safety factor 6.

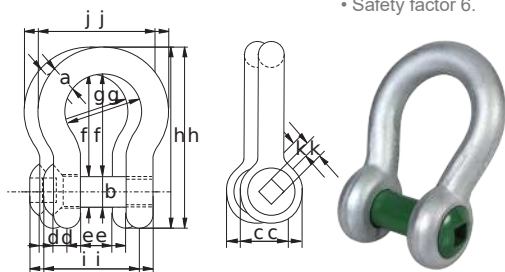

Grilli dritti Green Pin® Fishing FP con bullone con foro quadrato incassato

Green Pir® Fishing FP Dee Shackles with square sunken hole screw pin (flush pin)

Senza parti sporgenti che potrebbero rovinare le reti

Tipo G 4159

Con perno filettato

Acciaio alta resistenza gr. 6

Finitura: zincatura a caldo

No protruding parts so does not damage the nets

G 4159 type

With screw pin

Gr. 6 high tensile steel

Finish: hot dipped galvanized

Codice Code	Portata WLL t	Dimensioni Dimensions									Peso Weight Kg
		a mm	b mm	c mm	d mm	e mm	f mm	g mm	h mm	i mm	
AGRUVFP02	2	13,5	16	34	13	22	43	81	51	11	0,34
AGRUVFP03,2	3,25	16	19	40	16	27	51	97	63	11	0,6
AGRUVFP04,7	4,75	19	22	46	19	31	59	112	74	11	0,98
AGRUVFP06,5	6,5	22	25	52	22	36	73	134	85	13	1,26
AGRUVFP08,5	8,5	25	28	59	25	43	85	154	99	13	2,14
AGRUVFP09,5	9,5	28	32	66	28	47	90	167	110	17	3,05
AGRUVFP12	12	32	35	72	32	51	94	180	122	17	3,56
AGRUVFP17	17	38	42	88	38	60	127	230	145	17	6,84

- Coefficiente di sicurezza 6.
- Safety factor 6.

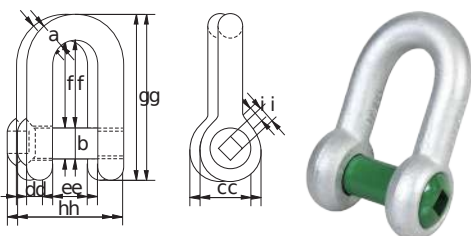

Chiave Green Pin® per grilli Fishing con fori quadrati incassati

Green Pin® sunken hole key for Fishing shackles with square sunken hole

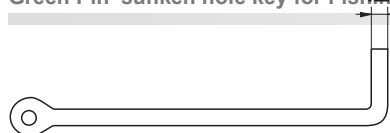



Accessori per fune

Wire rope fittings

GRILLI UNI 1947-A

UNI 1947-A SHACKLES

Tipo UNI 1947-A (EX)
Con perno filettato
Finitura: zincatura elettrolitica

UNI 1947-A type (EX)
With screw pin
Finish: electrolytic galvanized

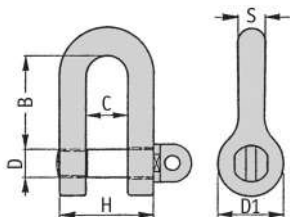

Codice Code	Portata WLL Kg	Dimensioni Dimensions							Peso Weight g
		D mm	D "	B mm	C mm	D1 mm	H mm	S mm	
AGRLUNI08	250	8	5/16	26	12	16	24	6	40
AGRLUNI10	400	10	3/8	33	16	19	32	8	80
AGRLUNI12	630	12	1/2	42	20	26	40	12	190
AGRLUNI14	800	14	9/16	46	22	29	44	13	250
AGRLUNI16	1000	16	5/8	50	24	32	48	14	320
AGRLUNI18	1300	18	11/16	54	26	35	53	15	430
AGRLUNI20	1600	20	3/4	58	28	38	58	17	590
AGRLUNI22	2000	22	7/8	69	32	44	68	20	930
AGRLUNI25	2500	25	1	79	36	50	78	23	1400
AGRLUNI28	3150	28	1 1/8	90	40	56	88	26	2200
AGRLUNI32	4000	32	1 1/4	100	45	64	99	29	2850
AGRLUNI36	5000	36	1 3/8	110	50	72	110	32	4400
AGRLUNI40	6300	40	1 9/16	120	55	80	123	36	5600
AGRLUNI42	8000	42	1 5/8	131	60	85	136	40	7560
AGRLUNI45	10000	45	1 3/4	143	65	90	149	45	10500
AGRLUNI50	12500	50	2	155	70	100	164	50	13900

- Coefficiente di sicurezza 5 • Su richiesta disponibili Grilli diritti con dado e coppiglia (ex UNI 1947-D).
- Safety factor 5 • Upon demand available dee shackles with safety bolt (ex UNI 1947-D).



Accessori per fune

Wire rope fittings

GRILLI Green Pin® di acciaio inossidabile

Green Pin® SHACKLES

Tipo R 7827

Con dado e coppiglia

R 7827 type
With safety bolt

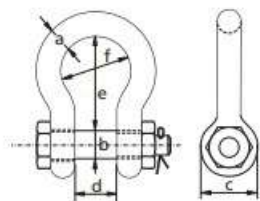

Codice Code		Portata WLL	Dimensioni Dimensions						Peso Weight	
R 7825	R 7827		t	a mm	b mm	c mm	d mm	e mm	f mm	R 7825 Kg
AGRLMIX00,3	AGRLDIX00,3	0,3	8	8	16	16	32	24	0,06	0,07
AGRLMIX00,4	AGRLDIX00,4	0,4	10	10	20	20	40	30	0,15	0,16
AGRLMIX00,6	AGRLDIX00,6	0,6	12	12	24	24	48	36	0,22	0,23
AGRLMIX01	AGRLDIX01	1	16	16	32	32	64	48	0,55	0,57
AGRLMIX01,5	AGRLDIX01,5	1,5	20	20	40	40	80	60	0,97	0,99
-	AGRLDIX02	2	22	22	44	44	88	66	-	1,46
-	AGRLDIX03	3	25	25	50	50	100	75	-	2,20

- Coefficiente di sicurezza 6.
- Safety factor 6.

Tipo R 7825

Con perno filettato

R 7825 type
With screw pin

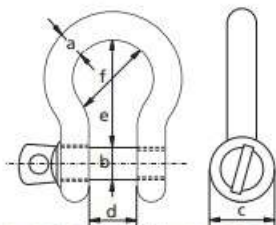

Acciaio inossidabile AISI 316
Finitura: lucidati

Stainless steel AISI 316
Finish: polished

Tipo R 7823

Con dado e coppiglia

R 7823 type
With safety bolt

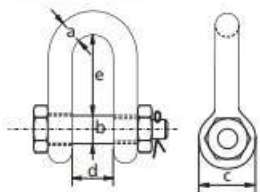

Codice Code		Portata WLL	Dimensioni Dimensions						Peso Weight	
R 7821	R 7823		t	a mm	b mm	c mm	d mm	e mm	R 7821 Kg	R 7823 Kg
AGRLUIX00,3	AGRLUDIX00,3	0,3	8	8	16	16	32	0,06	0,07	
AGRLUIX00,4	AGRLUDIX00,4	0,4	10	10	20	20	40	0,13	0,14	
AGRLUIX00,6	AGRLUDIX00,6	0,6	12	12	24	24	48	0,20	0,22	
AGRLUIX01	AGRLUDIX01	1	16	16	32	32	64	0,48	0,56	
AGRLUIX01,5	AGRLUDIX01,5	1,5	20	20	40	40	80	0,85	0,95	
AGRLUIX02	AGRLUDIX02	2	22	22	44	44	88	1,30	1,35	
-	AGRLUDIX03	3	25	25	50	50	100	-	2,10	

- Coefficiente di sicurezza 6.
- Safety factor 6.

Tipo R 7821

Con perno filettato

R 7821 type
With screw pin

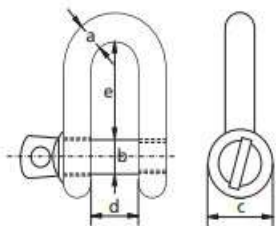

Acciaio inossidabile AISI 316
Finitura: lucidati

Stainless steel AISI 316
Finish: polished